

JF-SD-FA6310T-X18R

1MP AHD PTZ Camera

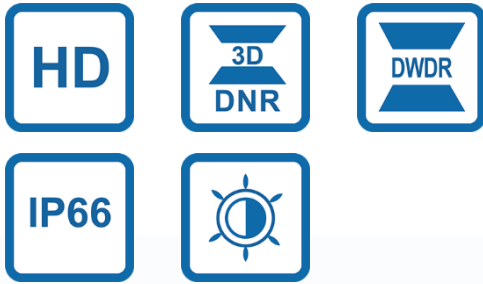

JF TECH



Features

- ◆ 18x Optical zoom
- ◆ Day/Night: IR-CUT
- ◆ 120m IR Distance
- ◆ AHD Video Output
- ◆ 3D Digital Noise Reduction
- ◆ IP66 Protection
- ◆ 360°endless pan range and -10°~90° tilt range
- ◆ PTZ functions: Up to 255 presets, up to 4 auto scan, up to 4 tour, up to 4 pattern

Specification

Camera	
Model	JF-SD-FA6310T-X18R
Size	6"
Frame Rate	25/30
Lens	4.7~84.6mm (18x Optical zoom)
Day/Night	IR-CUT
Max.IR Distance	120m
OSD Menu	En
WDR	DWDR
Noise Reduction	3D
Interface	
Video Output	AHD 1080P
Audio In	-
Alarm In/Out	-
General	
Pan/Tilt	Pan:0°~360°endless;Tilt:-10°~90°
Ingression Protection	IP66
Working Temperature	-20°~65°
Power	AC24V

JF-SD-FA6310T-X18R

1MP AHD PTZ Camera

Dimensions

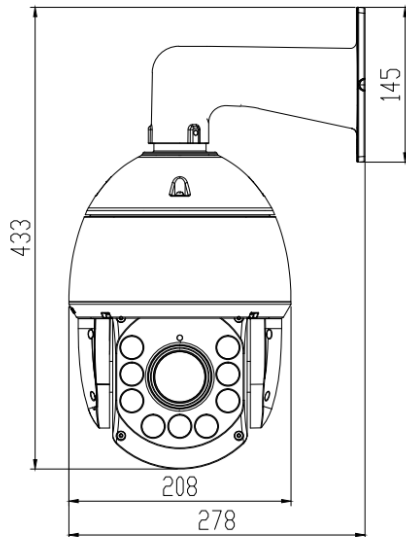

Accessories (optional)

JF TECH Co.,Ltd.
Headquarters(Hangzhou):
Building 9, Yinhu Innovation Center, Hangzhou, China
Business Center(Shenzhen):
A 7th Floor, Block Sakata 5 Avenue and Chong Hing Times Tower Shenzhen
All Rights Reserved • Specifications subject to change without notice.

Website:<http://www.jftech.com>
Tel:+86-0571-23271188

Tel:+86-0755-32898088